

Order no.: 800006

## Front-side railing, platform stairs

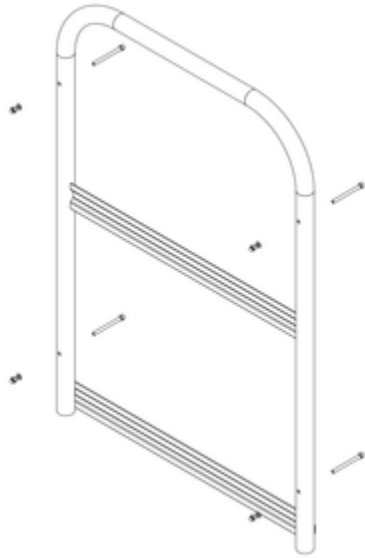

### Specification

Weight 2 kg	Transport dimensions 1100 x 750 x 100 mm, 2 kg	Business division MUNK Günzburger Steigtechnik	Order no. 800006	Price € 92.00
Spare part for article no. 056103	Spare part for article no. 056105	Spare part for article no. 050107	Spare part for article no. 050102	Spare part for article no. 056106
Spare part for article no. 054102	Spare part for article no. 054104	Spare part for article no. 055106	Spare part for article no. 058103	Spare part for article no. 050108
Spare part for article no. 056108	Spare part for article no. 055104	Spare part for article no. 056107	Spare part for article no. 055105	Spare part for article no. 050106
Spare part for article no. 051107	Spare part for article no. 055108	Spare part for article no. 055103	Spare part for article no. 050104	Spare part for article no. 058104
Spare part for article no. 058106	Spare part for article no. 058108	Spare part for article no. 058107	Spare part for article no. 055107	Spare part for article no. 054105
Spare part for article no. 051103	Spare part for article no. 054107	Spare part for article no. 050103	Spare part for article no. 056104	Spare part for article no. 050105
Spare part for article no.	Spare part for article no.	Spare part for article no.	Spare part for article no.	Spare part for article no.

058105	054108	051105	051106	054103
Spare part for article no. 054106	Spare part for article no. 051102	Spare part for article no. 051104	Spare part for article no. 051108	

## Facts

- High-quality spare part suitable for products from MUNK Günzburger Steigtechnik
- Robust and durable design. Quality. Made in Germany.
- Easy to install, with all the necessary fasteners
- Durable and safe, developed according to the highest quality standards
- If you are unsure about the spare part: Please open the product details page for your base product and select the appropriate spare part from the spare parts list

## Description

Our high-quality spare parts are specially developed to ensure the functionality and safety of our products in the long-term. Made from robust materials and manufactured to the highest quality standards, they offer the usual reliability that the MUNK brand stands for. The simple assembly and compatibility with the respective base products makes replacing quick and easy.

To find the right spare part, we recommend opening the product details page for the corresponding base product and using the spare parts list.

Rely on our proven quality: Safety. Made in Germany.

## Information on sustainability criteria

- Corporate certification: ISO 9001
- Corporate certification: ISO 14001
- Corporate certification: EN 1090
- Corporate certification: EcoVadis
- RoHS
- REACH
- The MUNK Group complies with a Code of Conduct
- The Supply Chain Act does not apply due to our size
- The materials used are listed in the technical specification
- Resource-saving production: own photovoltaic systems
- Energy-efficient consumption during production: LED lighting

- Repairability, durability and quality: 15-year warranty on series products made in Germany
- Recyclability: Our products are mostly made of aluminium, steel or wood and can be fed directly into the recycling process.
- Socially acceptable working conditions in production: fair wages, gender equality
- Economical and recyclable packaging: no use of polystyrene, predominantly use of wood and cardboard, small amounts of plastic
- No health hazards for the users

More product pictures

---

## Corporate certifications

---

on sustainability criteria



Management System  
ISO 9001:2015  
ISO 14001:2015  
[www.tuv.com](http://www.tuv.com)  
ID 9108612548

